

## Addison Instructions

### 1A

Watch our assembly videos at [www.stratafurniture.com/videos.html](http://www.stratafurniture.com/videos.html)

#### Parts in the Arm Box:

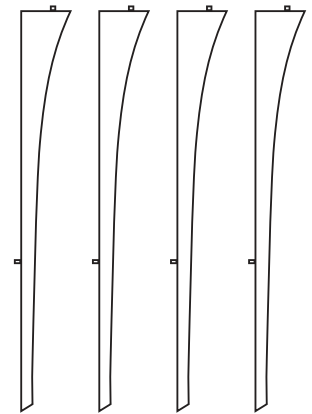
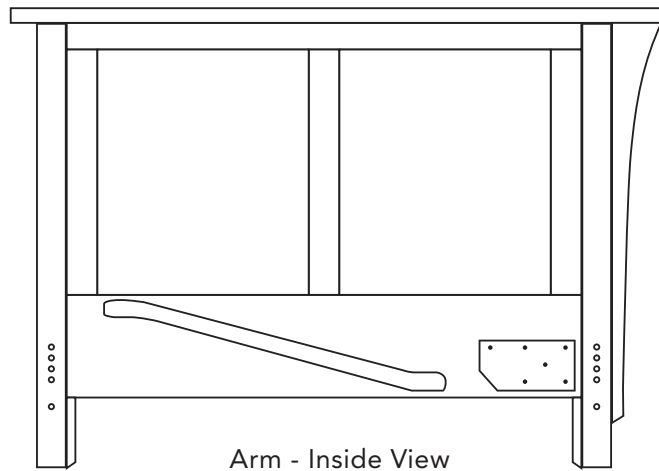
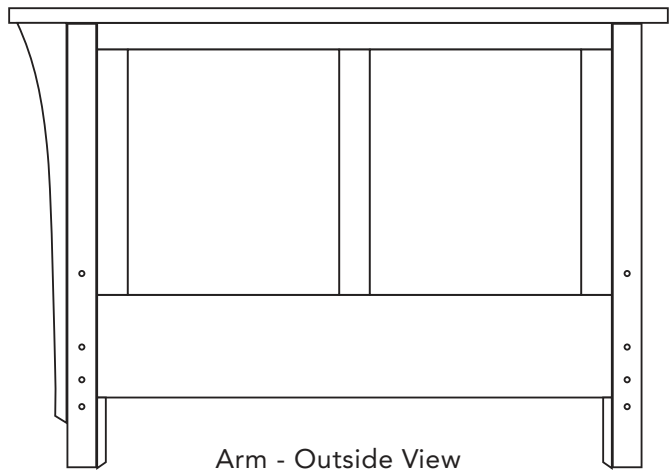

### 1B

#### Parts in the Body Box:

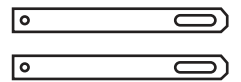
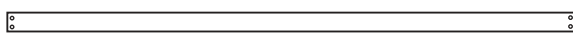
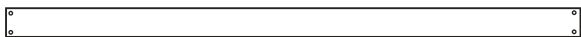
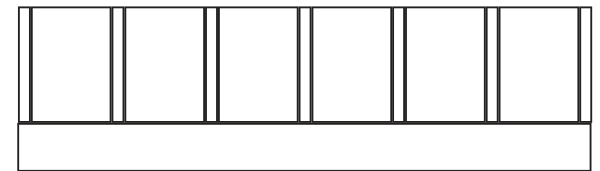
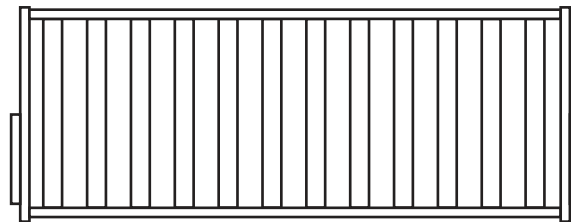
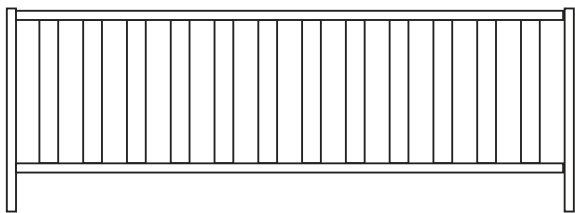

## Addison Instructions

### 2A

Hardware in the Body Box:



Long Bolts (80mm) x 10  
For the Stretcher and Back Panel



Short Bolts (30mm) x 2  
For the Back Panel Corbels

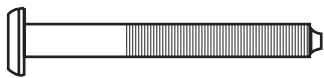

Bolts (60mm) x 6  
For the Advance Arms  
and the Foot Connector Bar

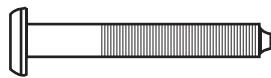

Bolts (50mm) x 4  
For the Arm Corbels

### 2B

Fit the Wooden Dowels into the Stretchers

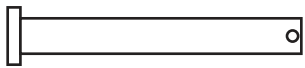
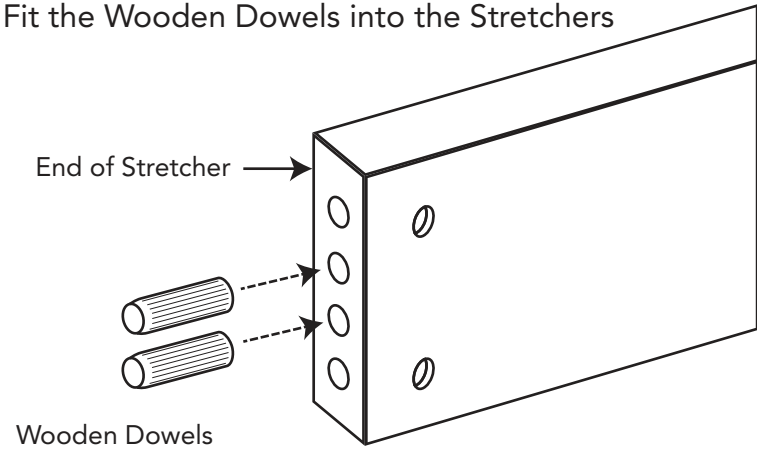

Long Clevis Pins x 2



Long Sleeve  
x 2



Short Sleeve  
x 4

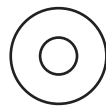

Washers x 8



Locking Pins x 4



Barrel Nuts x 10



Wooden Dowels x 12



Screw x 4

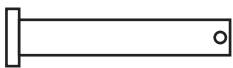

Short Clevis Pins x 2



Long Allen Key x 1



Plastic Runner x 2



Bungees x 2

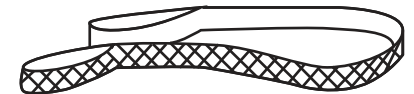

Strap x 1

## Addison Instructions

### 3A

Assemble the Back Panel between the Arms

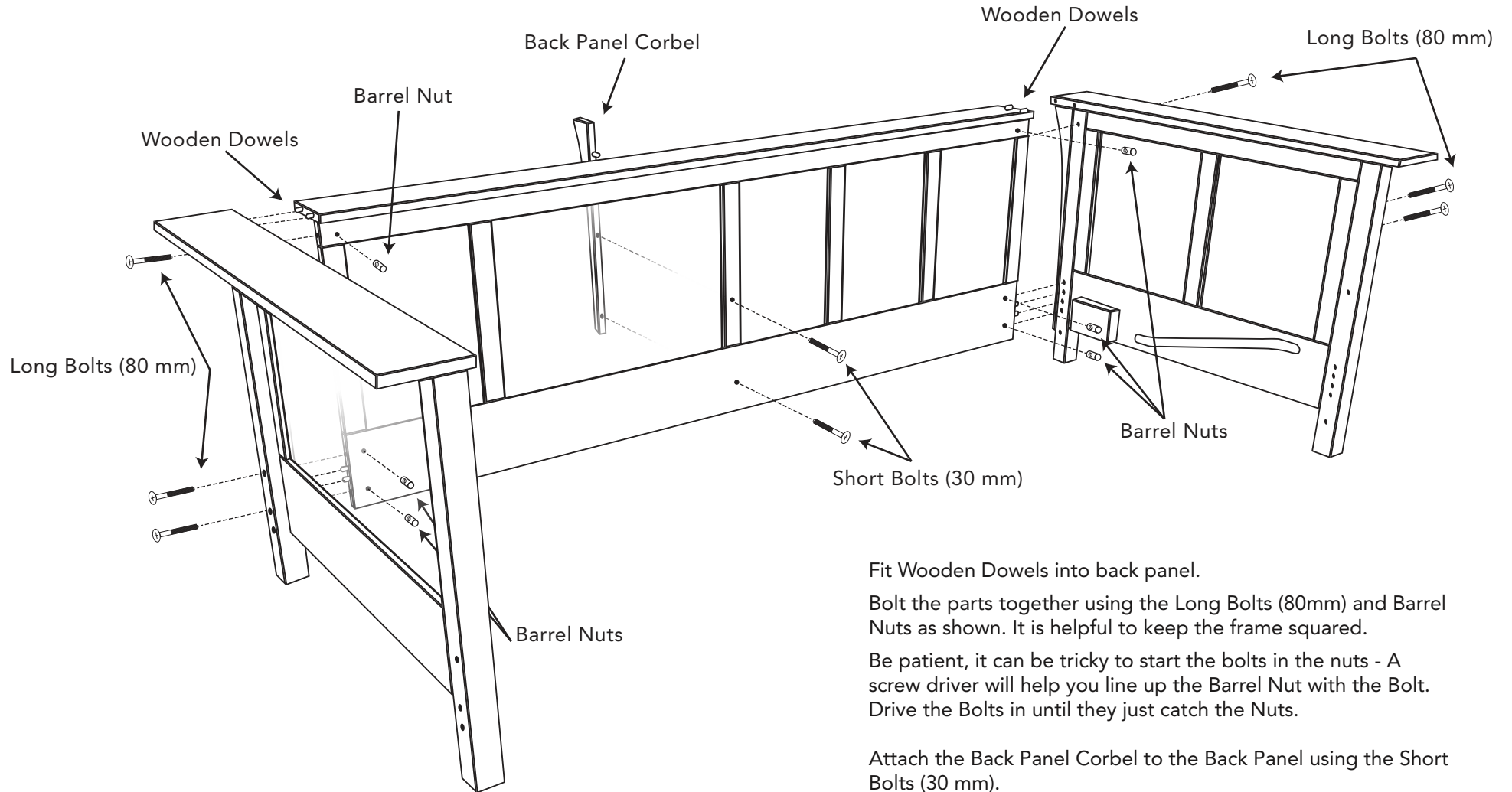

Fit Wooden Dowels into back panel.

Bolt the parts together using the Long Bolts (80mm) and Barrel Nuts as shown. It is helpful to keep the frame squared.

Be patient, it can be tricky to start the bolts in the nuts - A screw driver will help you line up the Barrel Nut with the Bolt. Drive the Bolts in until they just catch the Nuts.

Attach the Back Panel Corbel to the Back Panel using the Short Bolts (30 mm).

### 4A

Assemble the Stretcher between the Arms

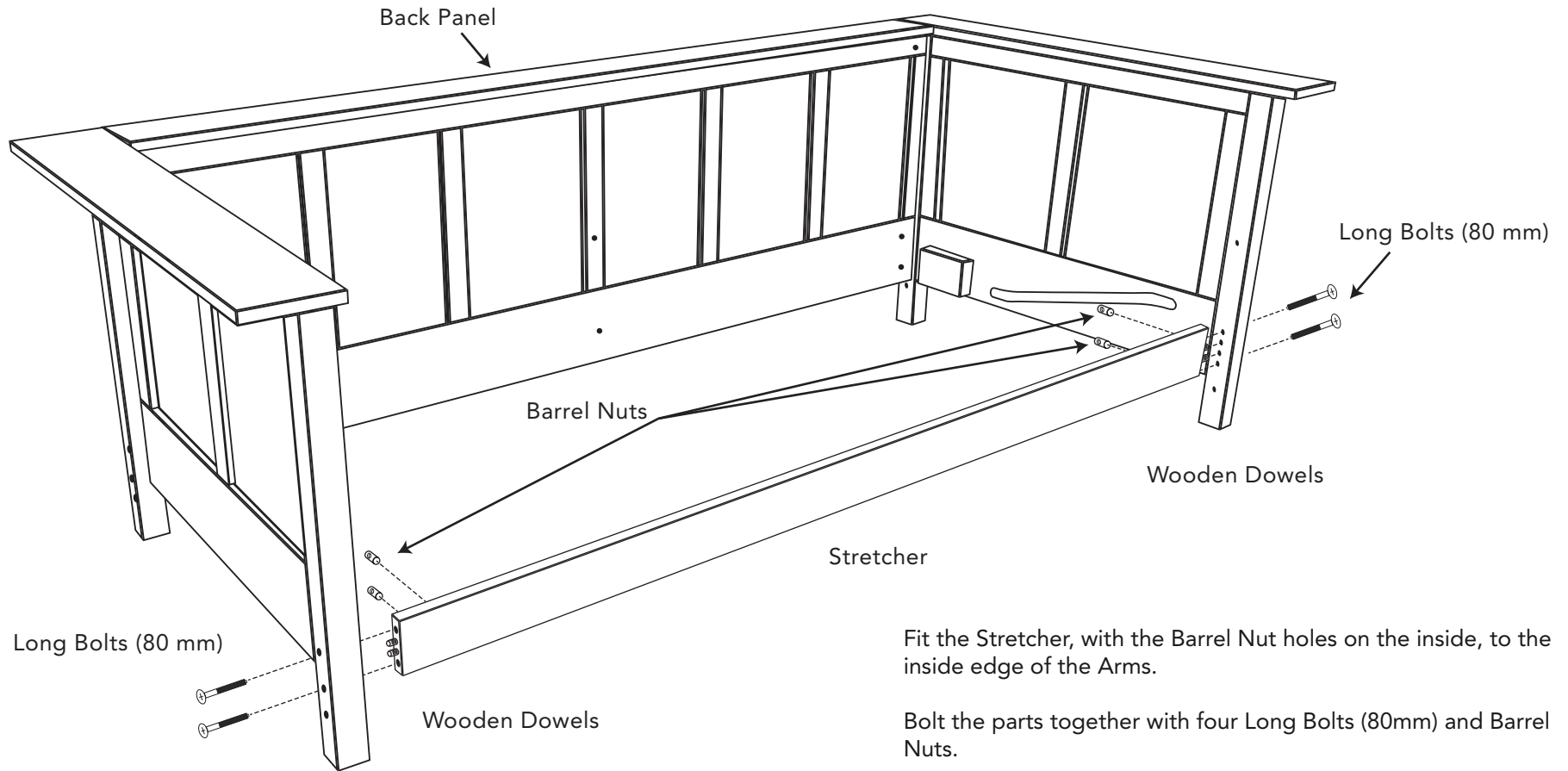

Fit the Stretcher, with the Barrel Nut holes on the inside, to the inside edge of the Arms.

Bolt the parts together with four Long Bolts (80mm) and Barrel Nuts.

Drive the Bolts in until they just catch the Nuts.

## Addison Instructions

### 5A

Join the Seat and Back Deck together.

Lay both Decks out flat on the floor with the *stickers facing upwards*.

The Seat Deck fits inside the Back Deck as shown. Slip the Long Clevis Pin through the small end of the Plastic Runner, then two small sleeves, then through the hole in the Back and Seat Deck. Secure with a Washer and Locking Pin.

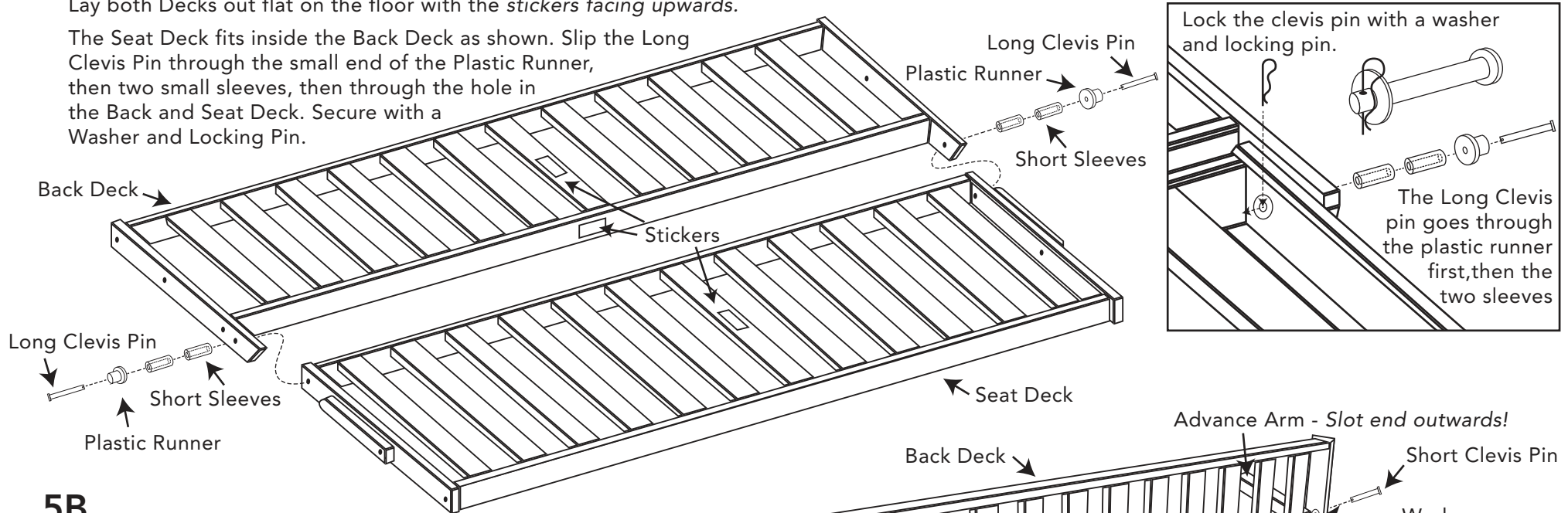

### 5B

Fit the Advance Arms to the Back Deck.

Rotate the Back Deck upright. Slide the short clevis pin through the back deck, then through a washer and then through the hole in the Advance Arm. Secure with a Locking Pin.

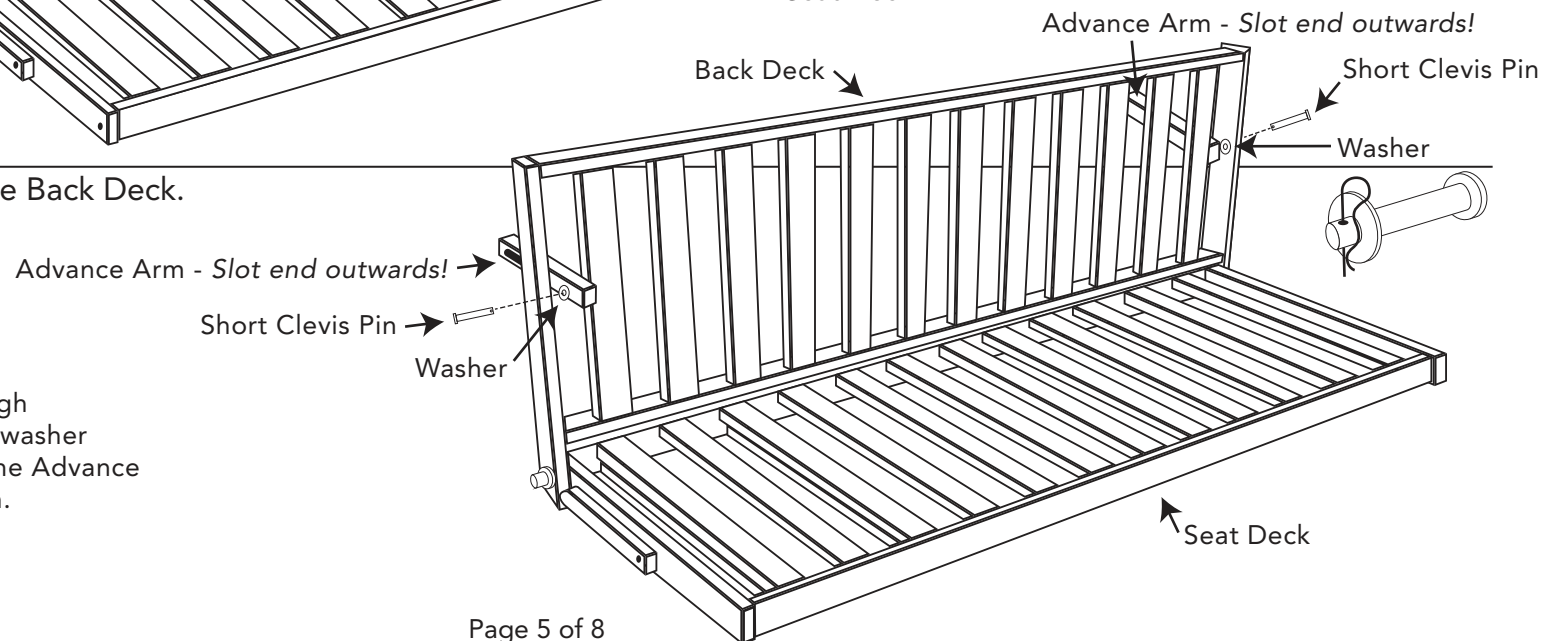

## Addison Instructions

### 6A

#### Attach the Connector Bar to the Legs.

Lift the Seat Deck so it is resting on the Back Deck, the feet should be pointing DOWNWARDS.

Line up the holes between the Connector Bar and the Feet. Make sure the recess for the bolt is facing outwards.

**CAUTION:** The metal insert in the foot **MUST** be facing the Back Deck.

Use four Bolts (60 mm) and bolt it in place.

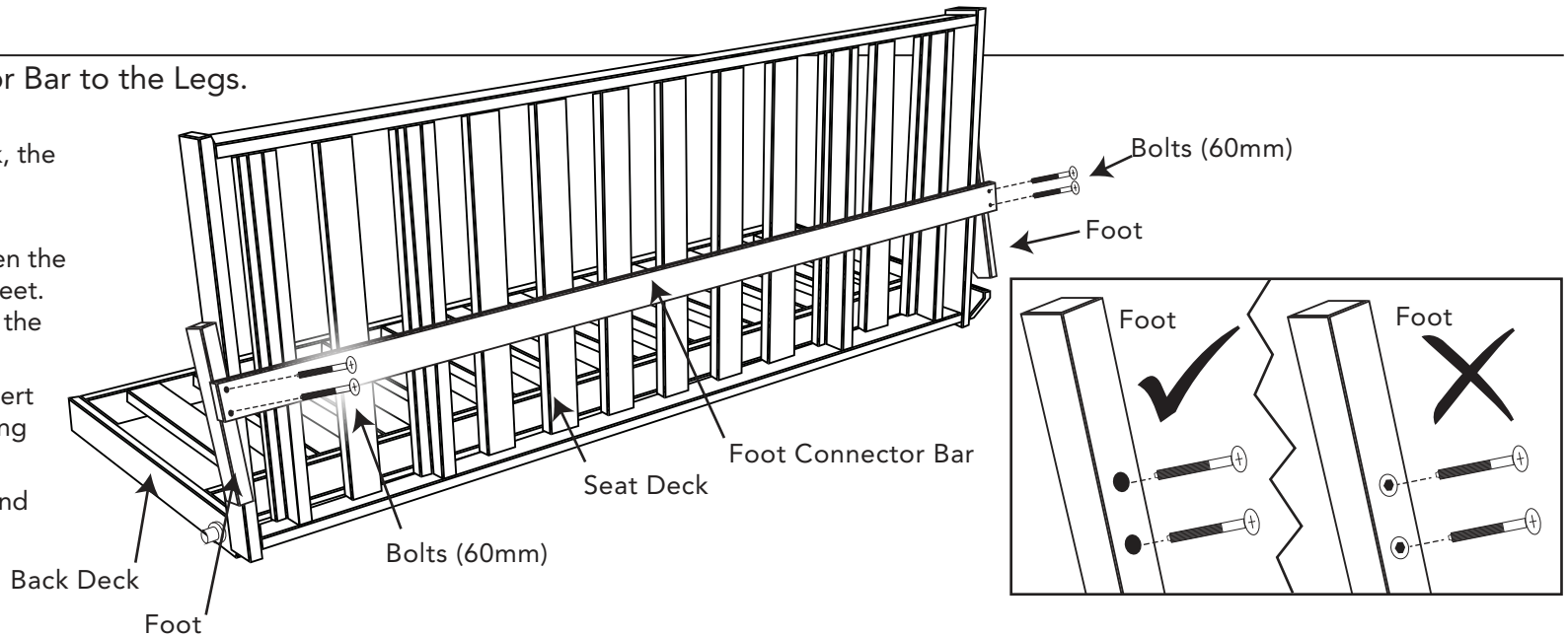

### 6B

#### Assemble the Bungees under the Seat Deck.

Screw the Bungees to the side of the two inner rails. Screw the lower end of the Bungee chord first, then stretch the Bungee over the Connector Bar. Screw in the top end.

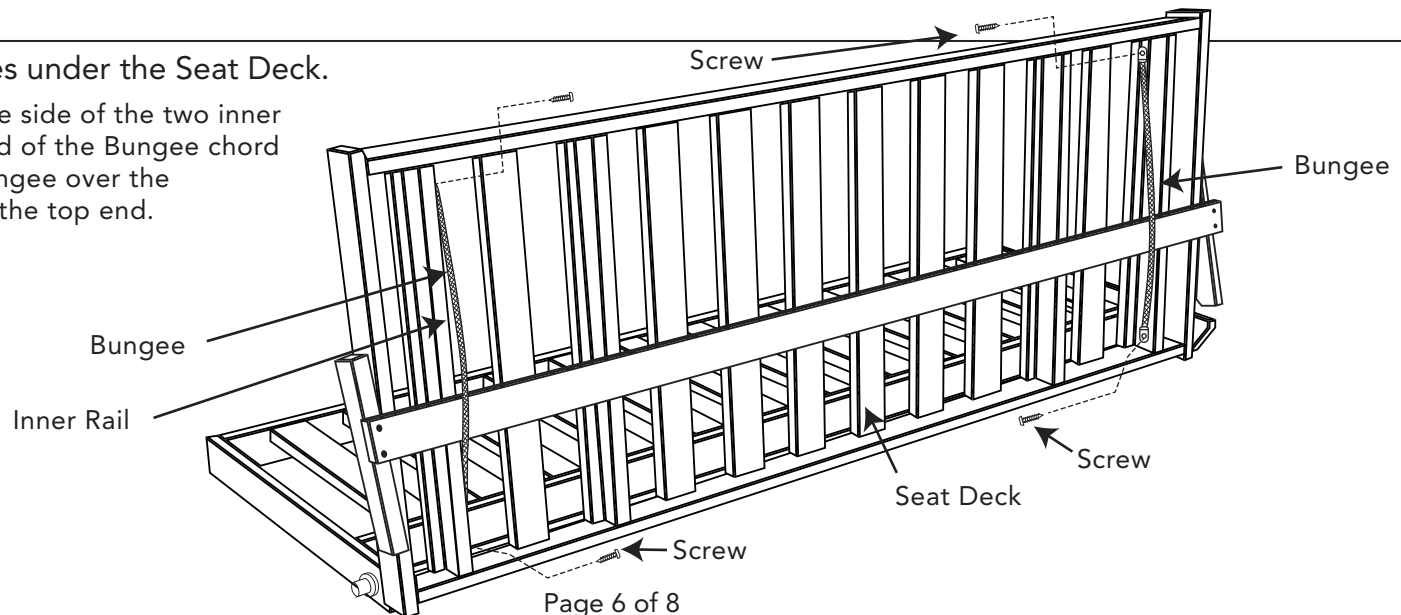

## Addison Instructions

### 7A

Fit the Seat Back Decks to the Frame.

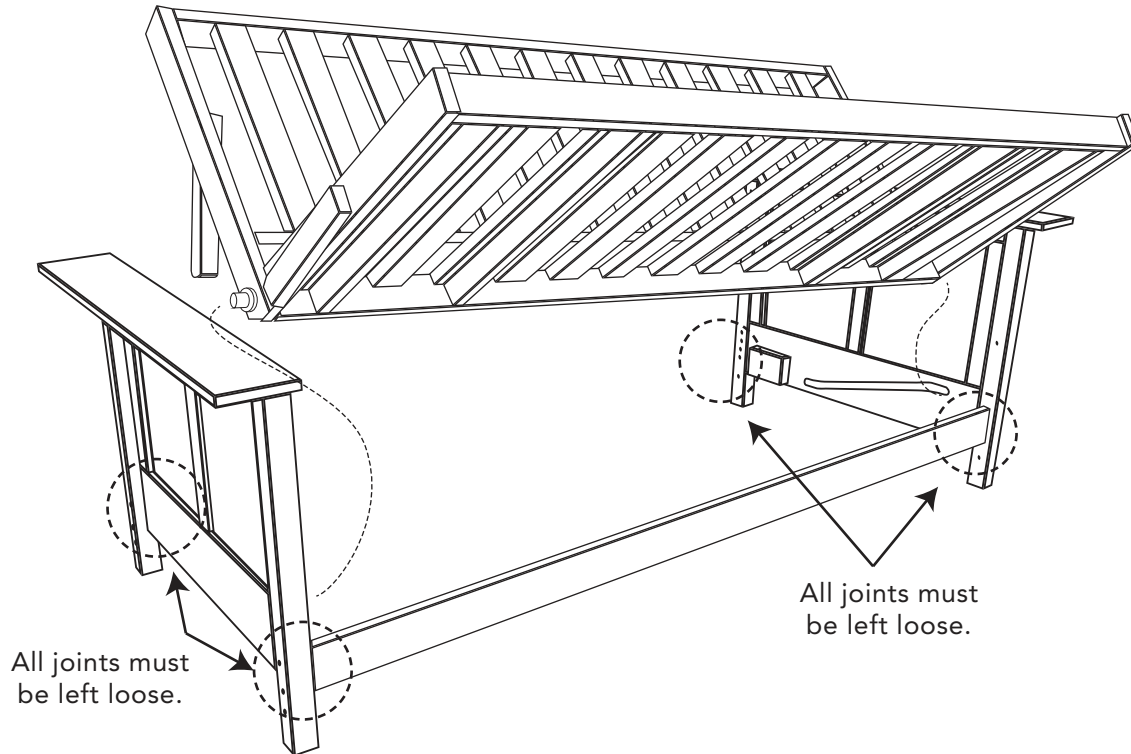

All joints must be left loose.

All joints must be left loose.

Insert the decks into the partially completed frame. This is where a helper may be useful.

When the Plastic Runners are in the grooves in the Arms, slide the assembly towards the back of the frame.

Tighten all Stretcher and Back Panel Bolts.

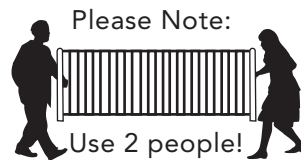

Please Note:

Use 2 people!

### 7B

Connect the Advance Arms to the Arms.

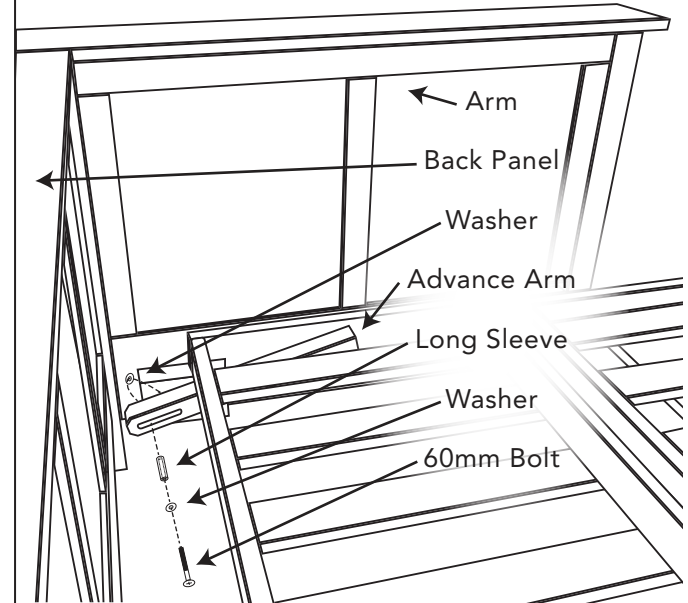

### 7C

Fit the Strap to the Back Deck





## Addison Instructions

### 8A

#### Attach the Corbels to the Arms.

Fit the dowel at the top of the Corbel into the hole on the underside of the Arm, and then fit the other dowel into the side of the Arm.

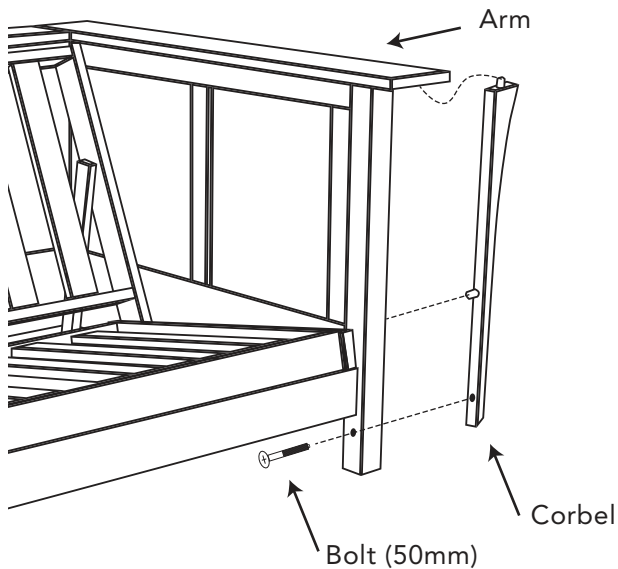

## Operating Instructions Watch our videos at [www.stratafurniture.com/videos.html](http://www.stratafurniture.com/videos.html)

#### To convert into a couch position

- Remove any pillows and other obstructions
- Push up the mattress into an inverted couch position and then lift up the seat deck into a vertical position.
- Resting seat deck on your hip, push the foot connector down all the way so that the foot connector rests on the side rail.
- With one hand lightly push the seat deck down. Then, at the same time, pull on the top of the mattress with one hand (or the strap if using a strap) and push in the seat deck with your other hand or leg until it locks in.

**\*DO NOT FORCE!** - Frame should operate easily.

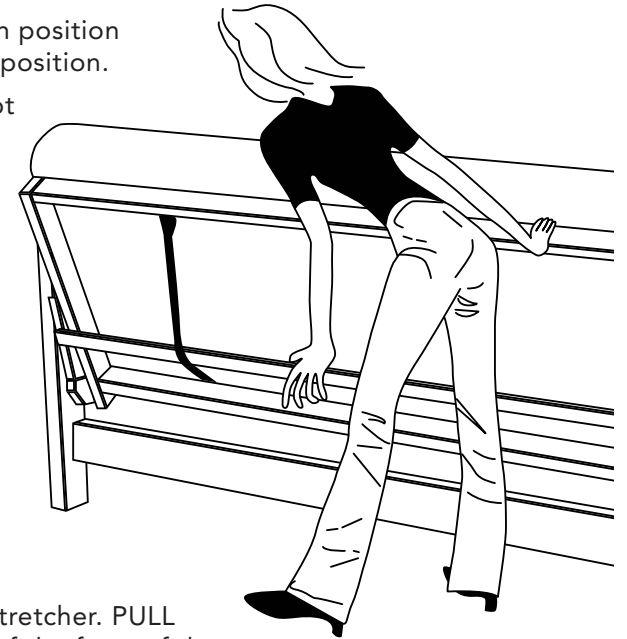

#### To convert into a bed position

- Lift seat deck up just so it clears the front stretcher. PULL HORIZONTALLY until the rollers hit the top of the front of the groove. Then lift into vertical position. At this point, it will look like the picture above. If you lift vertically too quickly, the frame will slam down.
- Resting the seat deck on your hip, push the seat deck and mattress forward (towards the back deck) until you can pull the foot connector bar out towards you until feet are fully extended.
- Sit the frame down gently.

**Note: Never lift the frame by the arm caps - Always lift from the bottom of the arms.**